

Safety shut-off valve JSAV 50–100

OPERATING INSTRUCTIONS

Cert. Version · Edition 01.23 · EN · 03250885



1 SAFETY

1.1 Please read and keep in a safe place



Please read through these instructions carefully before installing or operating. Following the installation, pass the instructions on to the operator. This unit must be installed and commissioned in accordance with the regulations and standards in force. These instructions can also be found at www.docuthek.com.

1.2 Explanation of symbols

1, 2, 3, a, b, c = Action

→ = Instruction

1.3 Liability

We will not be held liable for damage resulting from non-observance of the instructions and non-compliant use.

1.4 Safety instructions

Information that is relevant for safety is indicated in the instructions as follows:

⚠ DANGER

Indicates potentially fatal situations.

⚠ WARNING

Indicates possible danger to life and limb.

⚠ CAUTION

Indicates possible material damage.

All interventions may only be carried out by qualified gas technicians. Electrical interventions may only be carried out by qualified electricians.

1.5 Conversion, spare parts

All technical changes are prohibited. Only use OEM spare parts.

CONTENTS

1 Safety	1
2 Checking the usage	2
3 Installation	2
4 Connecting the impulse line	3
5 Connecting the breather line	3
6 Tightness test	3
7 Checking the function	4
8 Setting the trip pressure	4
9 Replacing the spring	4
10 Resetting	5
11 Replacing the measuring unit	5
12 Replacing the valve plate	5
13 Maintenance	6
14 Spare parts	6
15 Accessories	6
16 Technical data	7
17 Designed lifetime	7
18 Certification	7
19 Logistics	8
20 Disposal	8

2 CHECKING THE USAGE

Safety shut-off valve JSAV for securing downstream controls against excess gas pressure.

This function is only guaranteed when used within the specified limits – see page 7 (16 Technical data). Any other use is considered as non-compliant.

2.1 Type code

JSAV	Safety shut-off valve
50-100	Nominal size
T	T-product
F	Flange to ISO 7005
A	ANSI flange
50	p_u max. 5 bar
/1	Over-pressure shut-off p_{do}
-0	No pressure test point
Z	Special adjusting range

2.2 Part designations

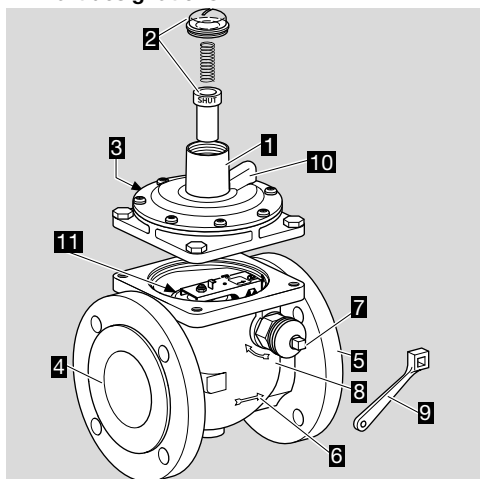

- 1 Measuring unit
- 2 Screw plug with position indicator
- 3 Connection for impulse line (closed with plastic plug)
- 4 Input
- 5 Output
- 6 Arrow of direction of flow
- 7 Reset
- 8 Arrow of direction of reset
- 9 Reset lever
- 10 Connection for breather line (closed with plastic plug)
- 11 Valve plate

2.3 Type label

Max. inlet pressure, upper trip pressure p_{do} , ambient temperature: see type label.

Elster GmbH, Germany		kron schöder	
JSAV		P_u max:	
		Wh_o:	
		P_{do}:	
		AGo: +/- 10%	
		TS=	

3 INSTALLATION

⚠ CAUTION

Incorrect installation!

Please observe the following to ensure that the unit is not damaged during installation and operation:

- Sealing material and dirt, e.g. thread cuttings, must not be allowed to get into the housing.
- We recommend installing a filter upstream of the valve in order to protect it against impurities in the pipe.
- Dropping the device can cause permanent damage. In this event, replace the entire device and associated modules before use.
- Do not clamp the unit in a vice or use it as a lever. Risk of external leakage.

- The installation location must be dry.
- Check max. inlet pressure $p_{u \max}$.
- Install the unit in the pipe free of mechanical stress.
- Installation in the vertical or horizontal position, never upside down.

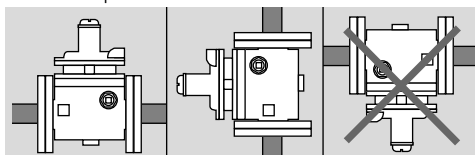

- The housing must not be in contact with masonry. Minimum clearance 20 mm (0.78"). Ensure that there is sufficient space for installation and adjustment.

- 1 Remove adhesive foil from the inlet and outlet on the JSAV.
- 2 Insert seal between pipe and unit.

3 Note direction of flow.

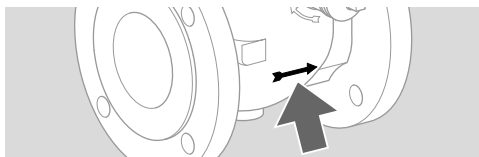

4 We recommend installing a manual valve AKT 25 in the pipe leading to the safety relief valve VSBV 25, so that the annual function check of the safety shut-off valve JSAV can be carried out without having to remove it.

5 To prevent the VSBV from being unintentionally shut off, we recommend removing the manual valve lever after commissioning and attaching it to the pipe.

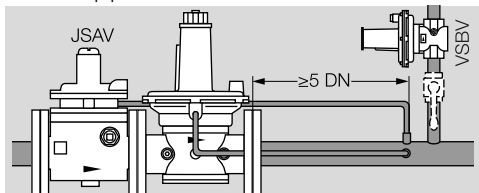

4 CONNECTING THE IMPULSE LINE

→ Ensure that there is sufficient tube length for the impulse line.

- 1 Remove the plastic plug in the impulse line connection.
- 2 Connect an Rp ¼ (¼ NPT) pipe. We recommend a pipe diameter of 12 x 1.5 mm.
- 3 Install the impulse line and seal with approved sealing material.

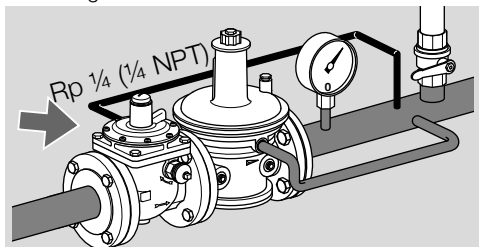

5 CONNECTING THE BREATHER LINE

- 1 Remove the plastic plug in the breather line connection.
 - 2 Connect an Rp ¼ (¼ NPT) pipe. We recommend a pipe diameter of 12 x 1.5 mm.
 - 3 Install the breather line and seal with approved sealing material.
- Route the breather line to a safe area.

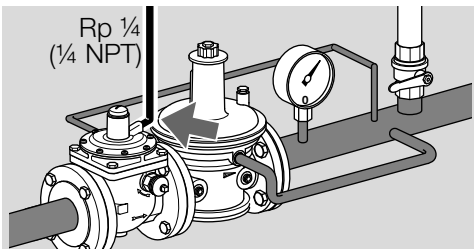

6 TIGHTNESS TEST

⚠ WARNING

Leaks!

Please observe the following to ensure that no damage occurs:

- If gas-filled spaces have been opened for maintenance work or replacement of spare parts, an additional tightness test must be carried out on the affected joints.
- Ensure that the valve seat of the JSAV is open, see page 5 (10 Resetting).
- 1 Block the pipeline at the inlet and outlet.
 - 2 Note max. test pressure. JSAV inlet and outlet: max. 7.5 bar (109 psig), impulse line: max. 750 mbar (10.9 psig).
 - 3 Slowly apply test pressure.

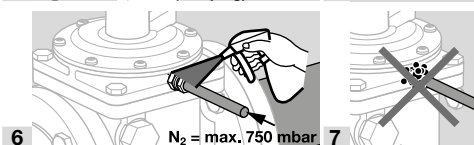
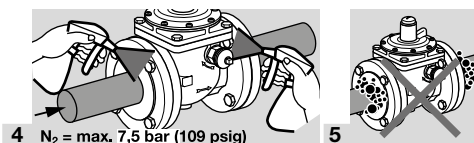
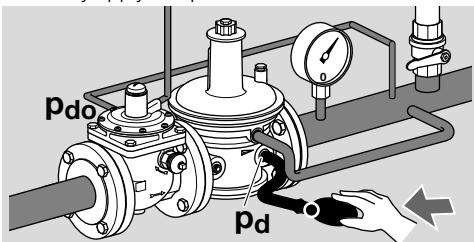

7 CHECKING THE FUNCTION

7.1 Checking the trip pressure

The JSAV is checked for the required trip pressure p_{do} .

- 1 Vent the system.
- 2 Ensure that the valve seat of the JSAV is open, see page 5 (10 Resetting).
- 3 Close all manual valves at the inlet and outlet, and in the breather line.

CAUTION

Please observe the following to ensure that the regulator is not damaged during the function check:

- Do not exceed the maximum outlet pressure p_d of the regulator.
- 4 Increase the outlet pressure p_d on the regulator until the required trip pressure p_{do} is reached.

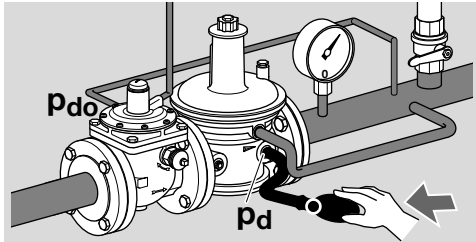

- The JSAV closes at the set trip pressure p_{do} . The red "SHUT" mark is visible.

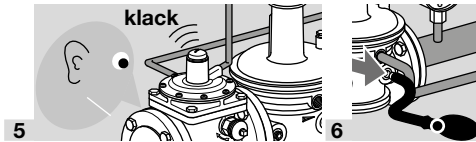

- 5
 - 6
- The JSAV has closed successfully: to restart the system, the JSAV must be opened again, see page 5 (10 Resetting).
 - The JSAV does not close at the required trip pressure p_{do} and must be readjusted, see page 4 (8 Setting the trip pressure).

7.2 Checking the tightness of the valve plate

- 1 Ensure that the JSAV and outlet gas line are closed.
- 2 Vent the system.
- 3 Slowly open the manual valve at the inlet.
- 4 The outlet pressure p_d must not rise.

8 SETTING THE TRIP PRESSURE

- 1 Select the trip pressure p_{do} according to the outlet pressure p_d of the pressure regulator.

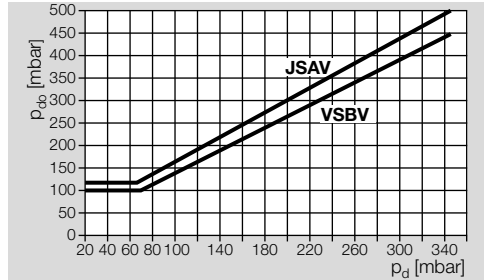

- 2 Remove the screw plug.
- Set the trip pressure p_{do} according to the diagram.

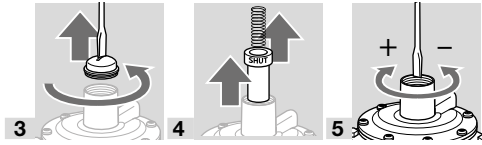

- If the JSAV has tripped, i.e. the "SHUT" mark is visible, reset it, see page 5 (10 Resetting).
- 6 Check the required trip pressure p_{do} again, see page 4 (7 Checking the function).
- 7 If the JSAV has been adjusted correctly, follow the reverse procedure when reassembling.

9 REPLACING THE SPRING

- Various trip pressure ranges can be achieved by using different springs on the JSAV.

- 1 Choose a spring according to the required trip pressure range.

Spring table for JSAV 50–100../1

Upper trip pressure p_{do}	Marking	Order No.
35–70 mbar 0.51–1.02 psig	light blue	03089063
60–170 ¹⁾ mbar 0.9–2.5 psig	reddish brown	03089064
120–220 mbar 1.74–3.2 psig	violet	03089065
190–400 mbar 2.8–5.8 psig	orange/ yellow	03089066
330–550 mbar 4.35–8 psig	orange/ green	03089067

1) Standard spring

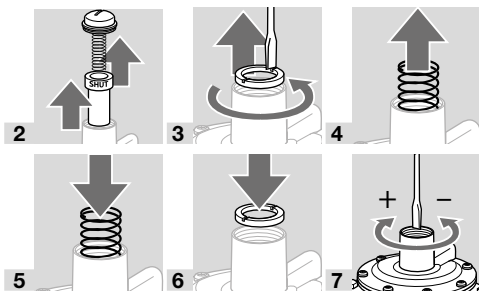

- 5
- 6
- 7
- 8 Adjust the required trip pressure p_{do} , see page 4 (8 Setting the trip pressure).
- 9 Follow the reverse procedure when reassembling.
- 10 After inserting the spring, take the spring's label from the packaging and stick it below the type label on the JSAV.
- 11 Clearly mark the adjusted value of the trip pressure p_{do} on the sticker.

10 RESETTING

The interlock is released by means of pressure equalization so that the closed JSAV can be reopened.

- 1 Ensure that the impulse line is depressurized.

⚠ CAUTION

Please observe the following to ensure that the JSAV is not damaged during resetting:

- Turn the reset lever gently and do not go further than specified.

- 2 Press the reset lever and turn through 10° until resistance can be felt.

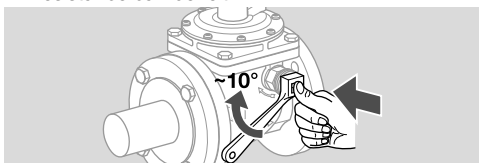

- 3 Hold the reset lever in this position until the lever can be easily turned further following pressure equalization.
 - 4 Press and turn the reset lever until the valve plate opens and clicks into place and the "SHUT" mark is no longer visible.
- The red "SHUT" mark must not be visible once the valve plate has clicked into place.
 - The JSAV is ready for operation.

11 REPLACING THE MEASURING UNIT

The measuring unit has to be replaced if the JSAV no longer opens or can no longer be reset.

- We recommend cleaning the O-ring seats and lightly greasing the O-rings with Klüber Nontrop ZB91 DIN before installation.
- 1 Depressurize the system.
 - The measuring unit is supplied with 1 O-ring and 4 screws.
 - 2 Ensure that the JSAV is closed. The red "SHUT" mark must be visible.
 - If the JSAV is open, apply pressure to the impulse line to close the valve.
 - 3 Detach the impulse and breather lines from the JSAV.

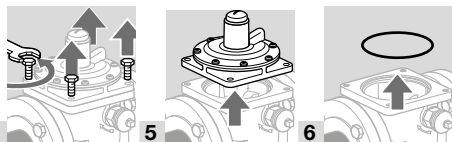

- 4
- 5
- 6
- 7 Install the new O-ring in the housing.
- 8 Follow the reverse procedure when reassembling.
- 9 Connect the impulse and breather lines to the JSAV.
- 10 Check tightness and function, see page 3 (6 Tightness test) and page 4 (7 Checking the function).

12 REPLACING THE VALVE PLATE

→ The valve plate has to be replaced if the JSAV is leaking or if it has been damaged during resetting.

→ We recommend cleaning the O-ring seats and lightly greasing the O-rings with Klüber Nontrop ZB91 DIN before installation.

- 1 Depressurize the system.
- We also recommend replacing the entire seal set and the bellows when replacing the valve plate.
- The seal set with bellows is available separately as a spare part.
- Ensure that the JSAV is closed. The red "SHUT" mark must be visible.
- If the JSAV is open, apply pressure to the impulse line to close the valve.
- 2 Detach the impulse and breather lines from the JSAV.

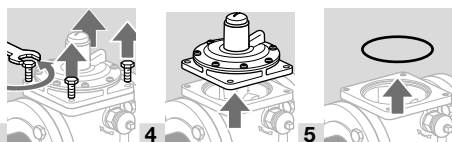

- Press the reset lever and turn until the valve plate is on top.

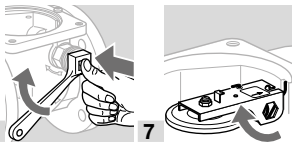

⚠ WARNING

Risk of injury!

The spring wire is under high stress.

- Carefully press the spring wire into the notch in the plate as shown.

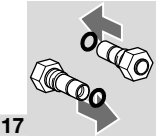
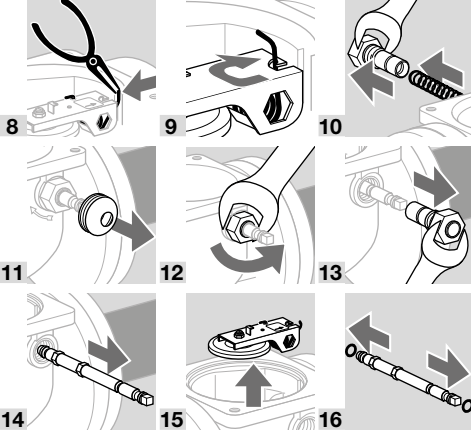

- Use new O-rings from the seal set for the assembly work.

18 Follow the reverse procedure when reassembling using the new valve plate and the new O-rings.

- To ensure that the valve plate is pushed onto the seat by the spring, the spring wire must be released from the notch in the plate and rest against the housing wall.

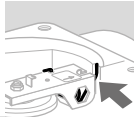

- 19**
- 20** Connect the impulse and breather lines.
- 21** Check tightness and function, see page 3 (6 Tightness test) and page 4 (7 Checking the function).

13 MAINTENANCE

In order to ensure smooth operation, check the function and tightness of the JSAV every year, or every six months if operated with biogas.

- In the case of malfunctioning, check the measuring unit and valve plate and replace if necessary. Selecting spare parts: see www.adlatus.org, PartDetective. Replacing spare parts: see page 5 (11 Replacing the measuring unit) and page 5 (12 Replacing the valve plate).
- After carrying out maintenance work or replacing spare parts, check for tightness and function, see page 3 (6 Tightness test) and page 3 (6 Tightness test).

14 SPARE PARTS

The PartDetective web app for selecting spare parts is available at www.adlatus.org.

15 ACCESSORIES

15.1 Position switch for remote indication

The position switch can be used for electronic position checks.

Order No.: 03151185

Part designations

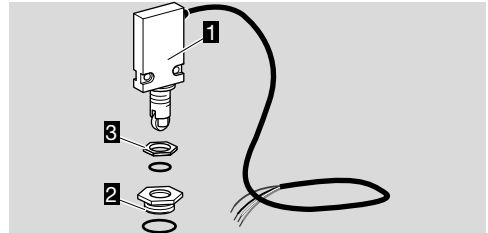

- 1** Position switch
- 2** Aluminium turned part
- 3** Lock nut

- Two washers and another lock nut which are included in the delivery are not required.

15.2 Using the position switch

- 1** Ensure that the JSAV is open. The red "SHUT" mark is not visible.

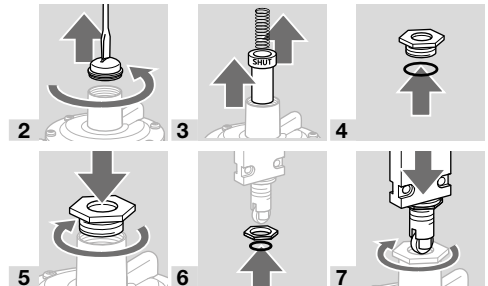

- 8** Screw in the position switch until the switching point is reached and then screw in a further half a turn.
- See the drawing labelled “Contacts” in the enclosed position switch installation and connection instructions for measuring the switching point.
- 9** Prevent the position switch from rotating using the fitted lock nut.
- 10** Wire the position switch.
- See the drawing labelled “Contacts” in the enclosed position switch installation and connection instructions for the electrical wiring.
- 11** After wiring, check for correct functioning, see page 4 (7 Checking the function).

16 TECHNICAL DATA

16.1 Ambient conditions

Icing, condensation and dew in and on the unit are not permitted.

Avoid direct sunlight or radiation from red-hot surfaces on the unit. Note the maximum medium and ambient temperatures!

Avoid corrosive influences, e.g. salty ambient air or SO₂.

The unit may only be stored/installed in enclosed rooms/buildings.

Ambient temperature: -20 to +60°C (-4 to +140°F).

Long-term use in the upper ambient temperature range accelerates the ageing of the elastomer materials and reduces the service life (please contact manufacturer).

Storage temperature: -20 to +40°C (-4 to +104°F).

Transport temperature: -20 to +60°C (-4 to +140°F).

The gas must be clean and dry in all temperature conditions and must not contain condensate.

This unit is not suitable for cleaning with a high-pressure cleaner and/or cleaning products.

16.2 Mechanical data for JSAV 50–100

Gas type: natural gas, town gas, LPG (gaseous), biogas (max. 0.02 %-by-vol. H₂S) = Group 1 fluids pursuant to Directive 2014/68/EU or air.

Medium temperature = ambient temperature.

Max. inlet pressure p_i: 5 bar (72.5 psig).

Max. test pressure for testing the JSAV:

inlet and outlet: temporarily < 15 min: 7.5 bar (109 psig),

impulse line: temporarily < 15 min:

750 mbar (10.8 psig).

Trip pressure p_{do} preset at the factory: 120 mbar (46.8 "WC).

Trip pressure ranges, see page 4 (9 Replacing the spring).

Accuracy group: AG 10.

Connection for housing:

JSAV.F: PN 16 flange to ISO 7005,

JSAV.A: ANSI flange.

Connection for impulse and breather lines: Rp 1/4 (1/4 NPT).

Housing: GGG 40.

Diaphragm: NBR.

Valve seat: aluminium.

Valve stem: stainless steel.

Valve plate: aluminium with vulcanized NBR seal.

17 DESIGNED LIFETIME

This information on the designed lifetime is based on using the product in accordance with these operating instructions. Once the designed lifetime has been reached, safety-relevant products must be replaced.

Designed lifetime (based on date of manufacture) in accordance with DIN EN 14382 for JSAV 50–100: 30 years.

You can find further explanations in the applicable rules and regulations and on the afecor website (www.afecor.org).

This procedure applies to heating systems. For thermoprocessing equipment, observe local regulations.

18 CERTIFICATION

18.1 Certificate download

Certificates – see www.docuthek.com

18.2 Declaration of conformity



We, the manufacturer, hereby declare that the product JSAV 50–100 with product ID No. CE-0085CO0530 complies with the requirements of the listed Directives and Standards.

Directives:

- 2014/68/EU – PED
- 2011/65/EU – RoHS II
- 2015/863/EU – RoHS III

Regulation:

- (EU) 2016/426 – GAR

Standards:

- DIN EN 14382:2009

The relevant product corresponds to the tested type sample.

The production is subject to the surveillance procedure pursuant to Regulation (EU) 2016/426 Annex III paragraph 3.

Elster GmbH

18.3 UKCA certified



Gas Appliances (Product Safety and Metrology etc. (Amendment etc.) (EU Exit) Regulations 2019)
BS EN 14382:2019

18.4 Eurasian Customs Union



The products JSAV 50–100 meet the technical specifications of the Eurasian Customs Union.

18.5 REACH Regulation

The device contains substances of very high concern which are listed in the Candidate List of the European REACH Regulation No. 1907/2006. See Reach list HTS at www.docuthek.com.

18.6 China RoHS

Directive on the restriction of the use of hazardous substances (RoHS) in China. Scan of the Disclosure Table China RoHS2, see certificates at www.docuthek.com.

19 LOGISTICS

Transport

Protect the unit from external forces (blows, shocks, vibration).

Transport temperature: see page 7 (16 Technical data).

Transport is subject to the ambient conditions described.

Report any transport damage on the unit or packaging without delay.

Check that the delivery is complete.

Storage

Storage temperature: see page 7 (16 Technical data).

Storage is subject to the ambient conditions described.

Storage time: 6 months in the original packaging before using for the first time. If stored for longer than this, the overall service life will be reduced by the corresponding amount of extra storage time.

FOR MORE INFORMATION

The Honeywell Thermal Solutions family of products includes Honeywell Combustion Safety, Eclipse, Exothermics, Hauck, Kromschroder and Maxon. To learn more about our products, visit ThermalSolutions.honeywell.com or contact your Honeywell Sales Engineer.

Elster GmbH
Strotheweg 1, D-49504 Lotte
T +49 541 1214-0
hts.lotte@honeywell.com
www.kromschroeder.com

Global centralized service deployment coordination:
T +49 541 1214-365 or -555
hts.service.germany@honeywell.com

20 DISPOSAL

Devices with electronic components:

WEEE Directive 2012/19/EU – Waste Electrical and Electronic Equipment Directive



At the end of the product life (number of operating cycles reached), dispose of the packaging and product in a corresponding recycling centre. Do not dispose of the unit with the usual domestic refuse. Do not burn the product.

On request, old units may be returned carriage paid to the manufacturer in accordance with the relevant waste legislation requirements.

Honeywell
kromschroder

Translation from the German
© 2023 Elster GmbH